



1



ZPJ

XM  
230-00/2

1

V6



5

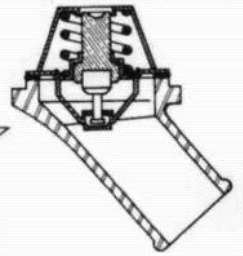
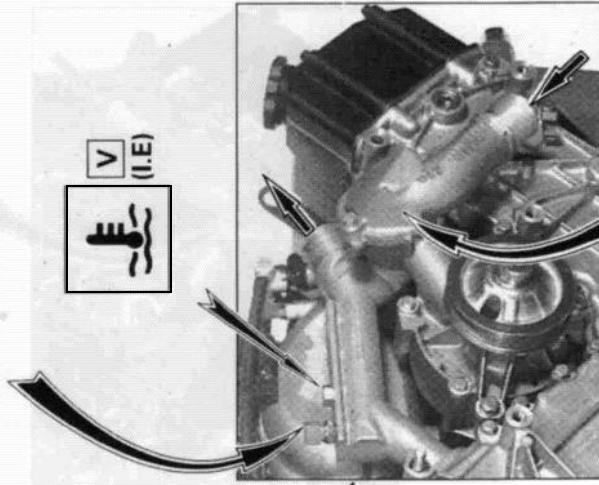
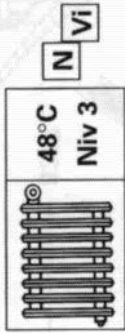

50% → -37°C



= 9,4 L

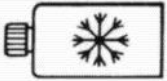

+



→ 06/91

06/91 →

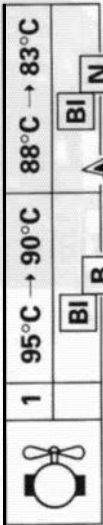

1,4 bar

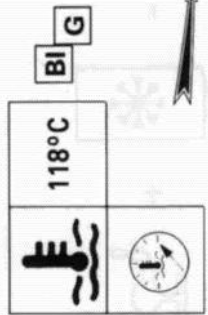
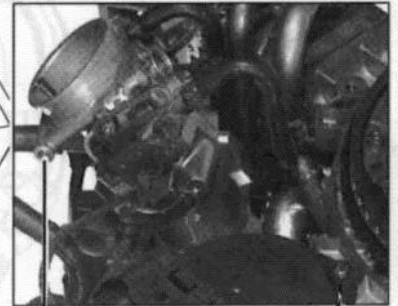
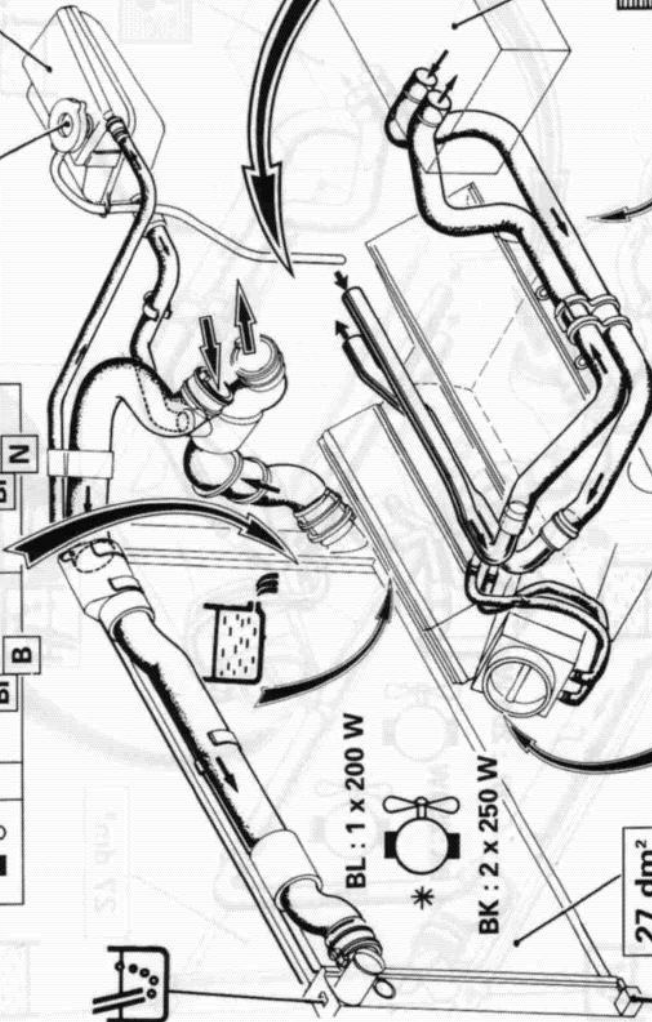

Y.23-4



V6



5

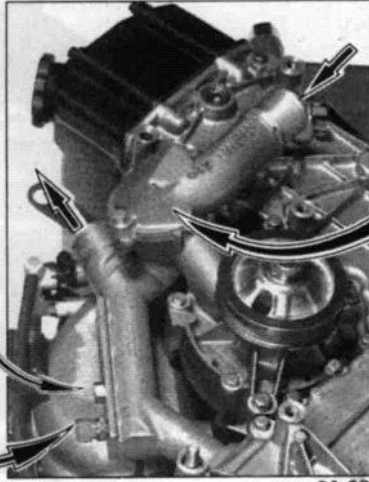

89-93

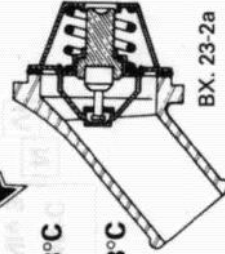
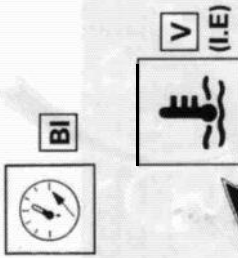

BX. 23-2a

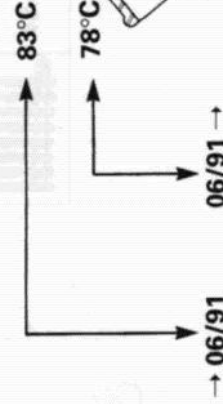

	→ 06/91	→ 06/91 →
1	95°C → 90°C	88°C → 83°C
2	100°C → 95°C	95°C → 90°C

50% → -37°C

1,4 bar



= 10 L



+

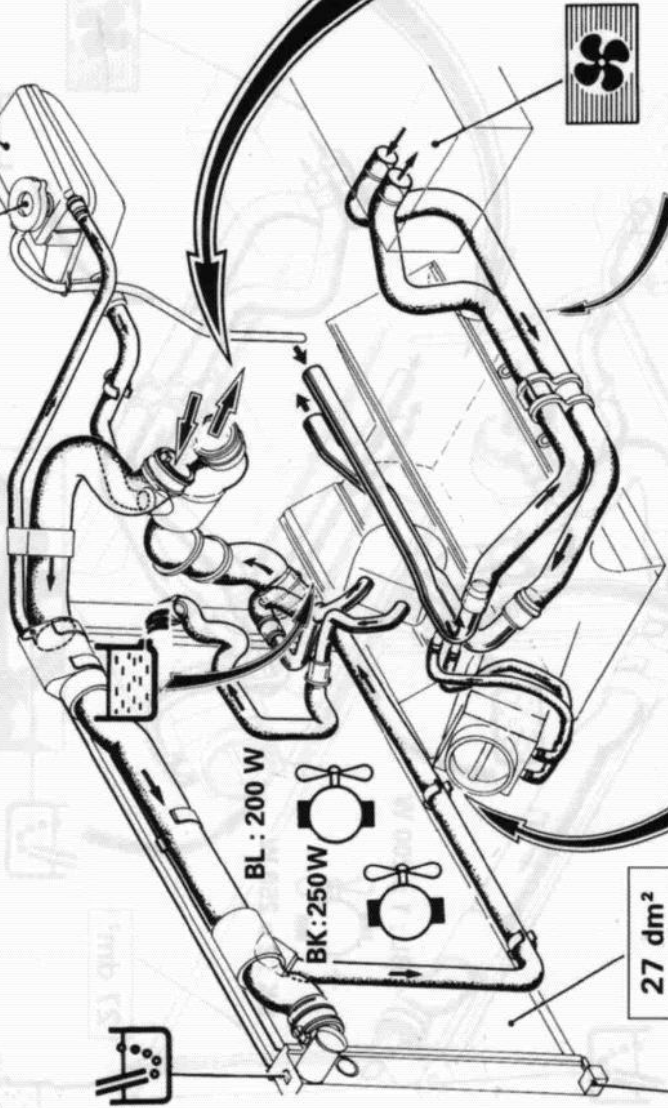

BL : 200 W

BK : 250 W

27 dm<sup>2</sup>

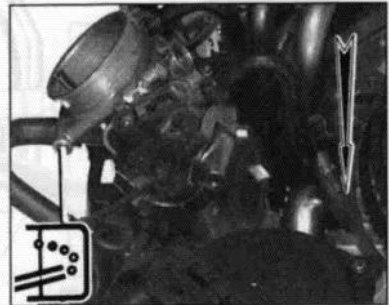

89-101

118°C	115°C	112°C

M



1

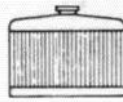

ZPJ

XM  
230-00/2

3

V6



AUTO

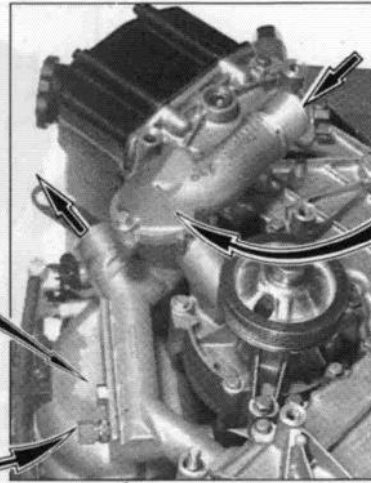
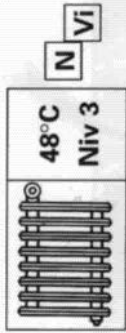

89-93

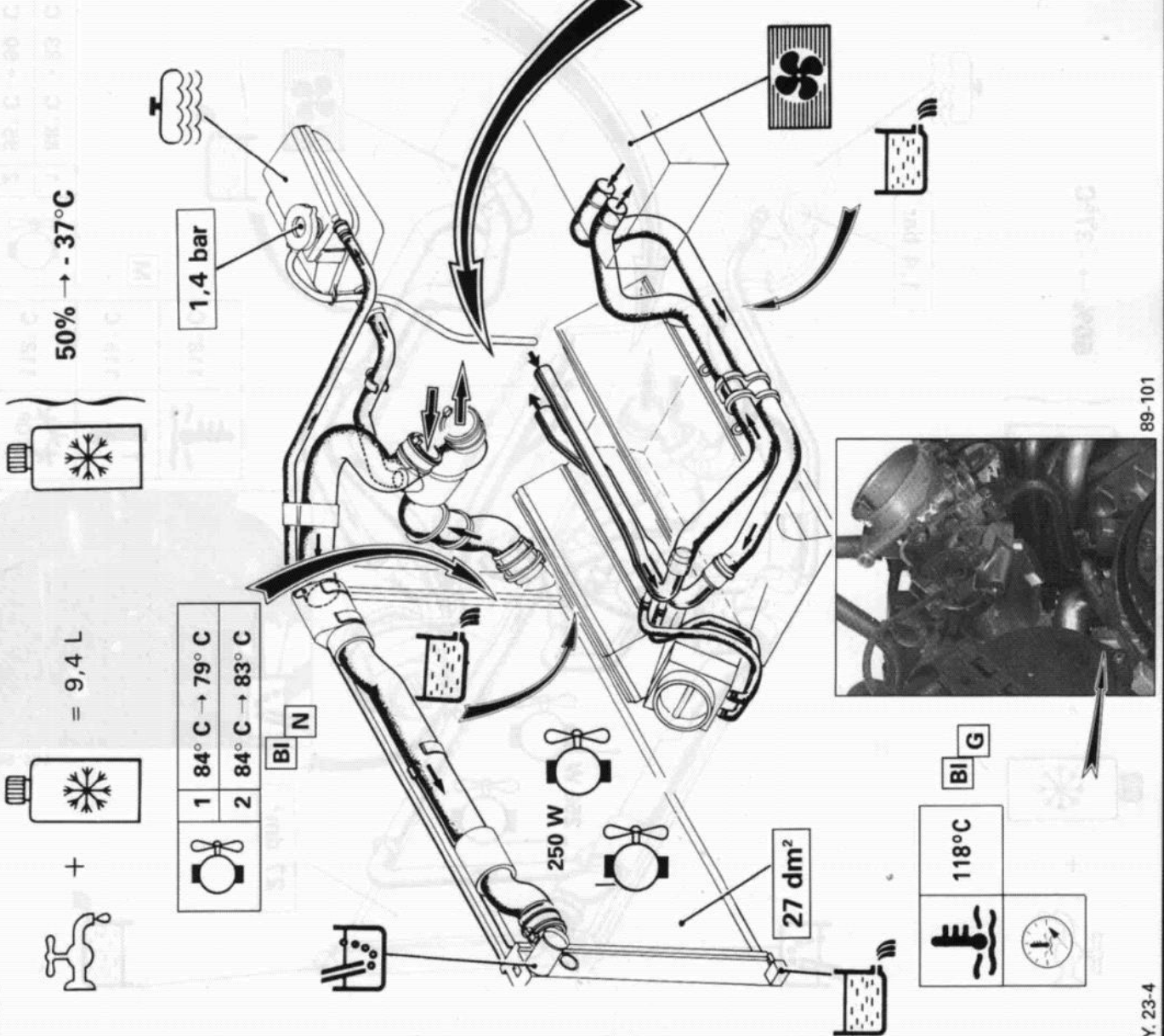
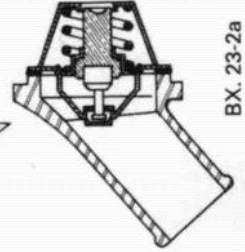

Y. 23-4



V6



AUTO



OTUA

78°C →

8V

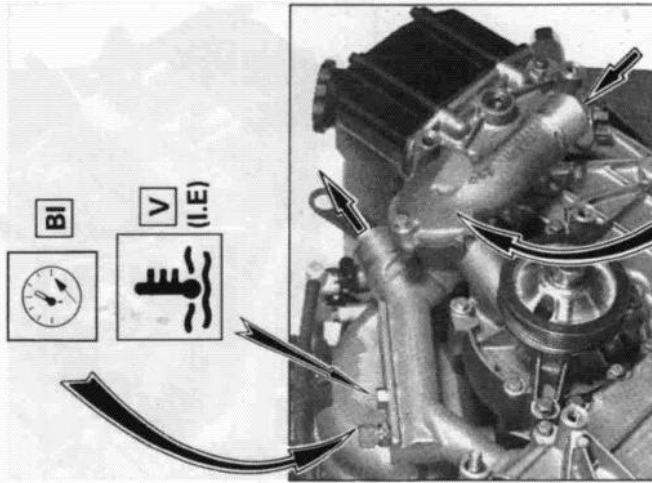

89-93

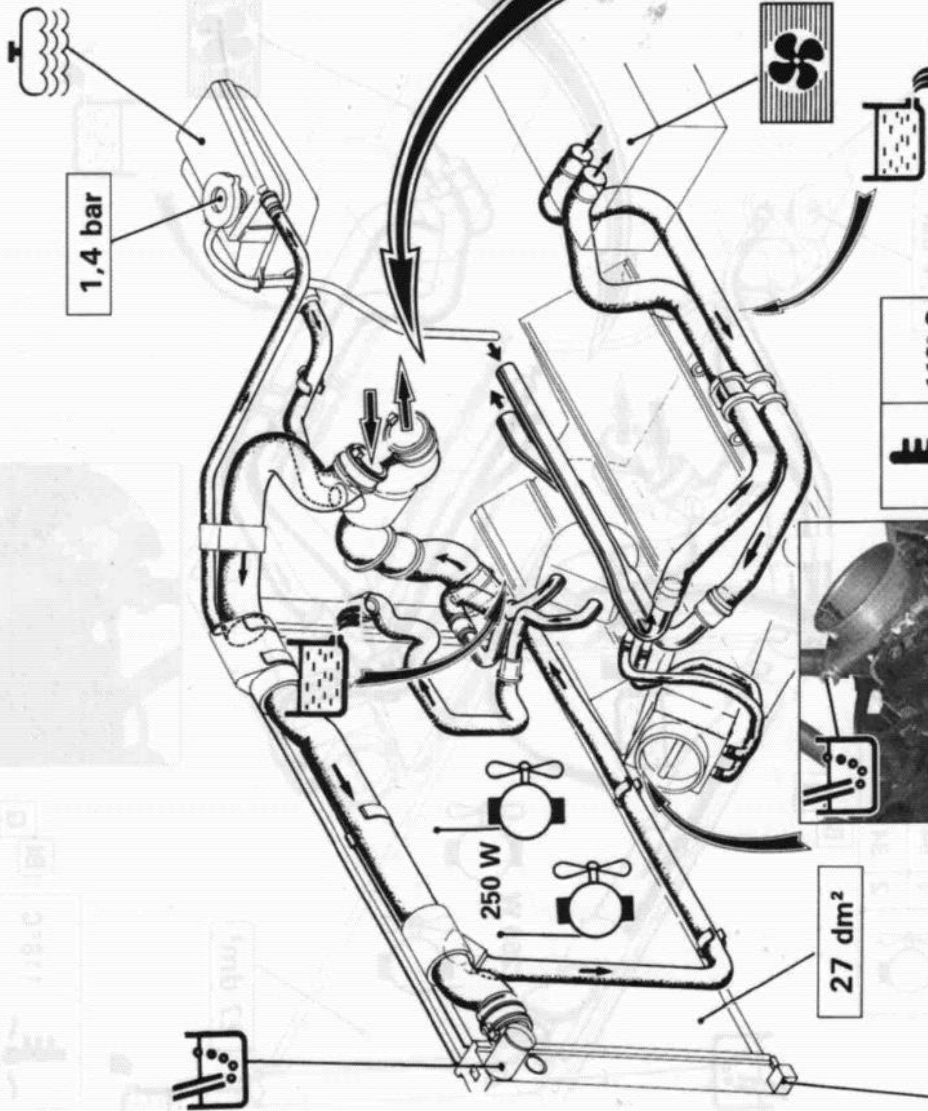
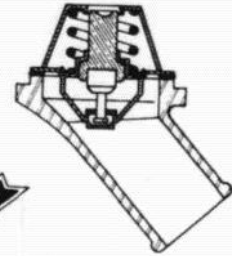

50% → -37°C

1,4 bar

M

1	88°C → 83°C
2	95°C → 90°C

118°C	115°C	112°C

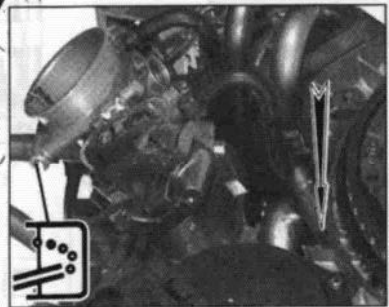

89-101

250 W

27 dm<sup>2</sup>

= 10 L



+





1



ZPJ

XM  
230-00/2

5

V6 - 24



5

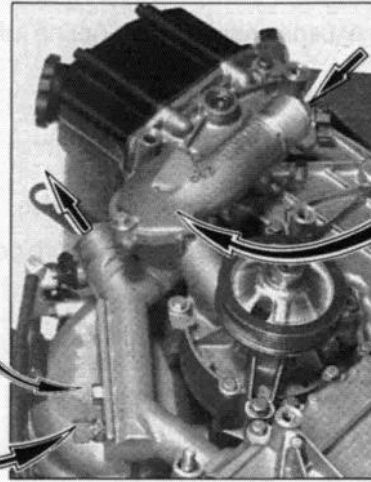

89-93

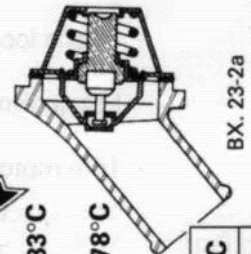
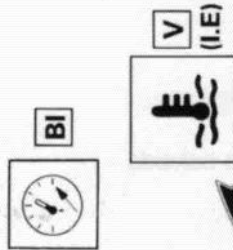

BX. 23-2a

83° C

83° C

78° C

06/91 →

1	95° C → 90° C	88° C → 83° C
2	100° C → 95° C	95° C → 90° C

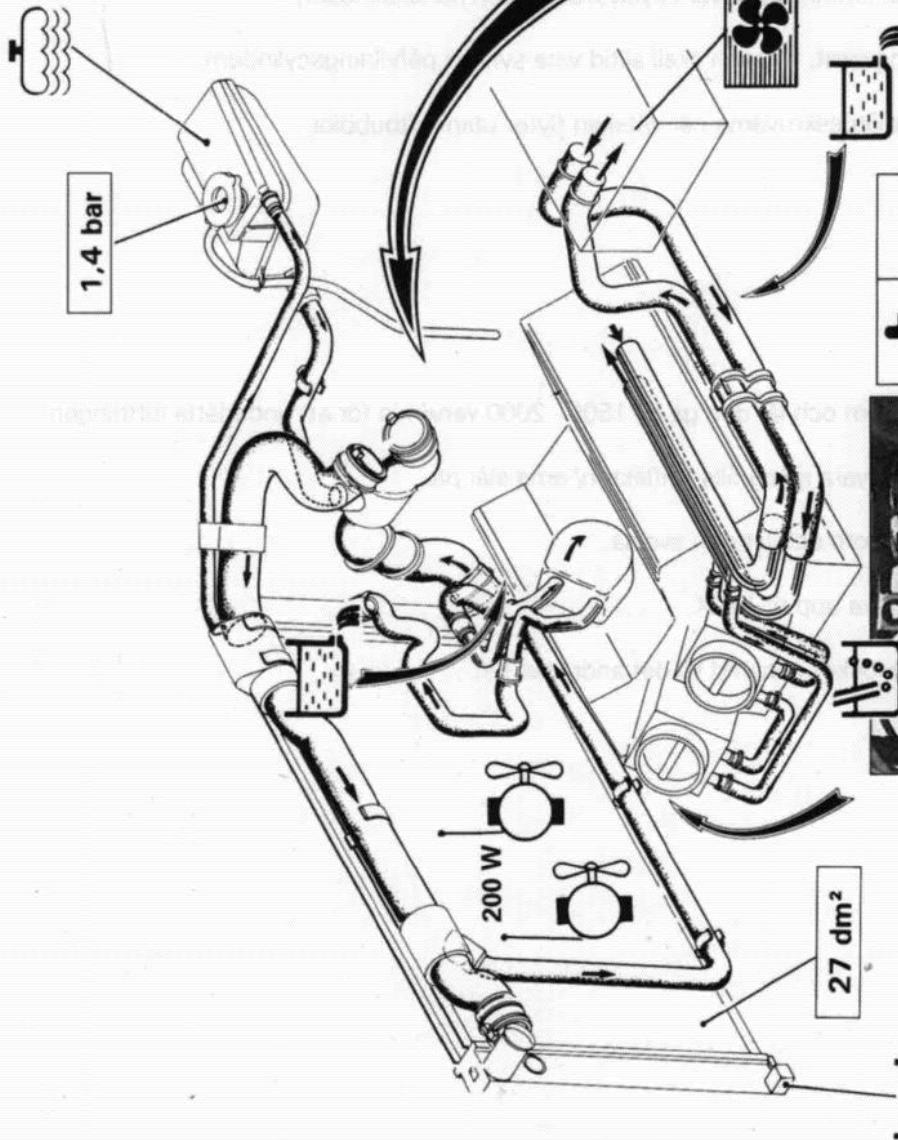

50% → - 37° C

1,4 bar

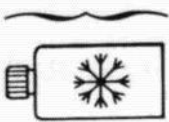

= 10 L



+



118° C	115° C	112° C

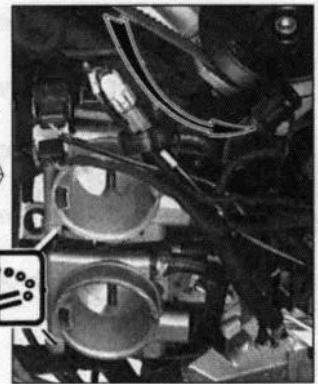

90-1469

200 W

27 dm<sup>2</sup>

M

Y. 23-12



### Tömning

- Öppna locket på expansionskärlet och öppna luftningskruven.
- Lossa tömningsskruven på kylaren.
- Töm motorblocket genom :
  - Pluggen på motorblockets framsidan,
  - Tappen (för gummislang) på motorblockets baksida.

### Påfyllning

- Placera påfyllningscylindern **4520-T** i kylarens påfyllningshål.
- Öppna alla luftningsskruvar i kylsystemet och på spjällhusen.
- Fyll på långsamt, vätskan skall alltid vara synlig i påfyllningscylindern.
- Stäng luftningsskruvarna när vätskan flyter utan luftbubblor.

### Luftning

- Starta motorn och låt den gå på 1500 - 2000 varv/min för att underlätta luftningen.
- Låt motorn vara igång tills kylfläkten/-arna slår på.
- Stoppa motorn och låt den svalna.
- Fyll på vätska upp till MAX.
- Skruva på locket och vrid till det andra hacket.